

# GLASS HARDWARE



## Linkan UK & Ireland Ltd

483 Green Lanes  
London  
N13 4BS  
UNITED KINGDOM  
Tel: +44 7853 459692  
Email: info-ukl@linkan-group.com



## Linkan North America, LLC

Woolworth Building  
233 Broadway, Suite 2200  
New York, NY 10279  
Tel: +1 212 608 6500  
Email: info-lkn@linkan-group.com



## Linkan Panama, S.A

Plaza Beverly,  
Calle 4 Rio Abajo,  
Local #13,  
Tel: 2217699/2249962  
Email: info-lkp@linkan-group.com



## Linkan Zhuhai Ltd

Building 31-7, A2 Doorway Business Park,  
No. 29 Xianggong Road, Hongwan,  
Xiangzhou, Zhuhai,  
Guangdong 519000, China  
Tel: +86 756 2170771  
Fax: +86 756 2170772  
Email: info@linkan-group.com



## Linkan Ltd

4th Floor, Hong Kong Trade Centre  
161 Des Voeux Road,  
SAR of Hong Kong,  
China  
Tel: +852 8114 2684  
Fax: +852 3159 8467  
Email: info@linkan-group.com

*Source with Ease & Confidence!*





## About Us

The Group is a specialized multinational company in the supply of high quality bathroom and construction materials.

Our headquarters are strategically located in China providing direct access between our customers and factories so we will have control of the entire process; from the placement of orders, production, quality control, shipping and delivery.

With the combination of years of experience in the supply of raw materials, components and finished products for the construction and manufacturing industries, we create value added services for our customers, along with competitive prices and excellent quality. Our teams continuously work to find solutions for the needs of our customers.

## Our Hardware

Our fittings have been selected based on quality that complies with European and American industry standards, are competitively priced and carry up to 10 years guarantee for manufacturing defects.

**LINKAN**



## Hardware for Bathrooms

Hinges P4

Handles - Knobs P6

Towel bars P10

## Hardware for Glass

Connectors for doors and facades P14

Locks P22

Spider Clamps & Anchors P24



# HARDWARE FOR BATHROOMS

## For a bathroom that suits you

High Quality Finishes  
Durable Design  
Various Colour Options



**POLISHED**

**SATIN**

### HINGE, WALL TO GLASS - POLISHED

SH-2121-P



Glass thickness: 8-12mm  
 Door width: ≤800mm  
 Bearing weight: ≤45kg  
 Main material: Stainless Steel/Copper  
 Finish: Polished

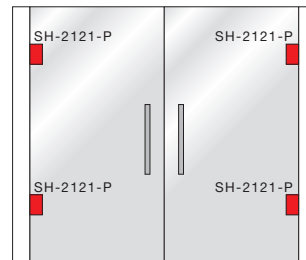
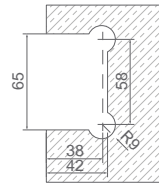
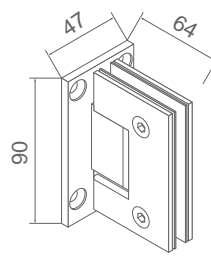

### HINGE, WALL TO GLASS - SATIN

SH-2121-S



Glass thickness: 8-12mm  
 Door width: ≤800mm  
 Bearing weight: ≤45kg  
 Main material: Stainless Steel/Copper  
 Finish: Satin

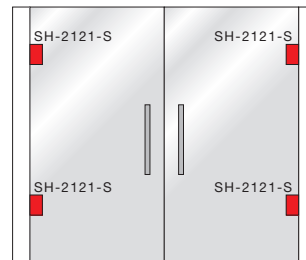
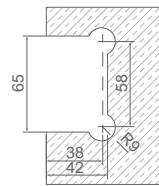
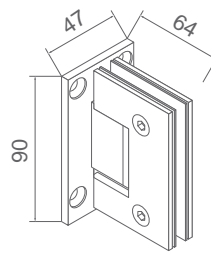

### HINGE, GLASS TO GLASS 180 DEGREES - POLISHED

SH-2123-P



Glass thickness: 8-12mm  
 Door width: ≤800mm  
 Bearing weight: ≤45kg  
 Main material: Stainless Steel/Copper  
 Finish: Polished

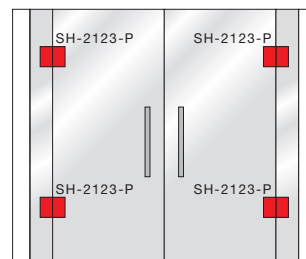
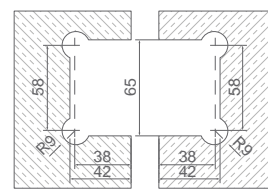
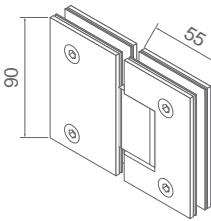

### HINGE, GLASS TO GLASS 180 DEGREES - SATIN

SH-2123-S



Glass thickness: 8-12mm  
 Door width: ≤800mm  
 Bearing weight: ≤45kg  
 Main material: Stainless Steel/Copper  
 Finish: Satin

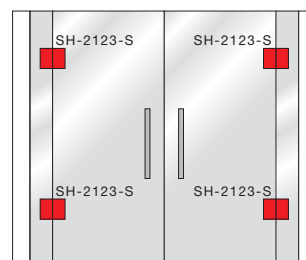
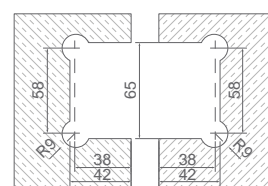
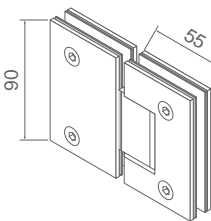

### HINGE, GLASS TO GLASS 135 DEGREES - POLISHED

SH-2124-P



Glass thickness: 8-12mm  
 Door width: ≤800mm  
 Bearing weight: ≤45kg  
 Main material: Stainless Steel/Copper  
 Finish: Polished

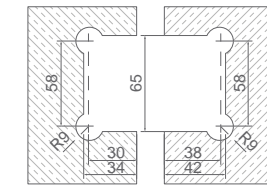
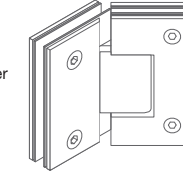

Fijo

Puerta

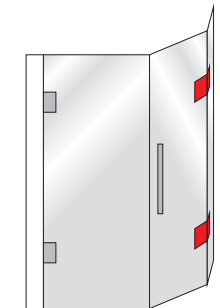

SH-2124-P

SH-2124-P

### HINGE, GLASS TO GLASS 135 DEGREES - SATIN

SH-2124-S



Glass thickness: 8-12mm  
 Door width: ≤800mm  
 Bearing weight: ≤45kg  
 Main material: Stainless Steel/Copper  
 Finish: Satin

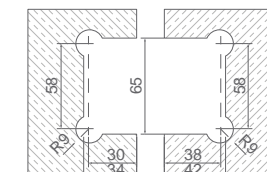
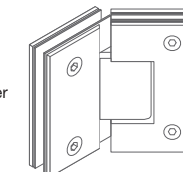

Fijo

Puerta

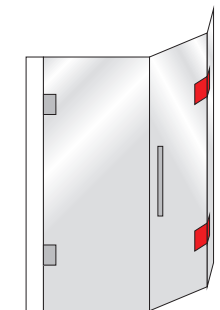

SH-2124-S

SH-2124-S

### HINGE, GLASS TO GLASS 90 DEGREES - POLISHED

SH-2125-P



Glass thickness: 8-12mm  
 Door width: ≤800mm  
 Bearing weight: ≤45kg  
 Main material: Stainless Steel/Copper  
 Finish: Polished

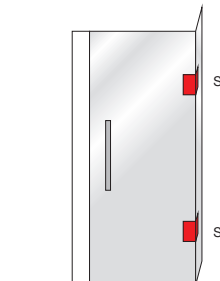
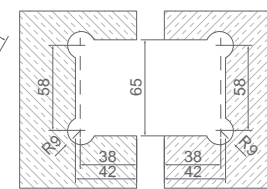
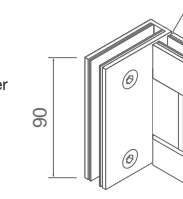

SH-2125-P

SH-2125-P

### HINGE, GLASS TO GLASS 90 DEGREES - SATIN

SH-2125-S



Glass thickness: 8-12mm  
 Door width: ≤800mm  
 Bearing weight: ≤45kg  
 Main material: Stainless Steel/Copper  
 Finish: Satin

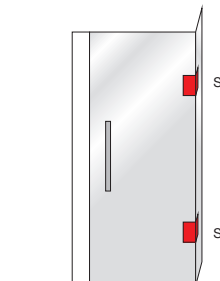
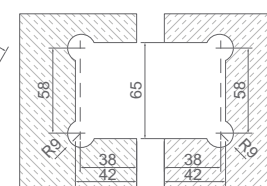
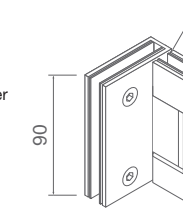

SH-2125-S

SH-2125-S

### DOUBLE SIDED DOOR KNOB - POLISHED

SH-2800D-P



Glass thickness: 6-12mm  
Main material: Stainless Steel/Copper  
Finish: Polished  
ø Hole Diameter 10 mm

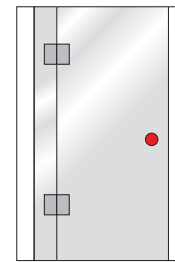
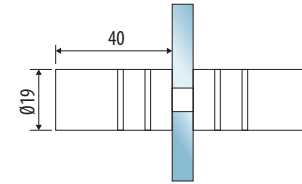
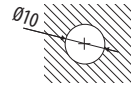

SH-2800D-P

### DOUBLE SIDED DOOR KNOB - SATIN

SH-2800D-S



Glass thickness: 6-12mm  
Main material: Stainless Steel/Copper  
Finish: Satin  
ø Hole Diameter 10 mm

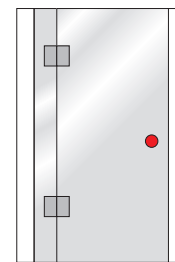
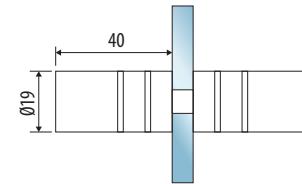
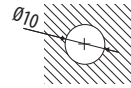

SH-2800D-S

### SINGLE SIDED DOOR KNOB - POLISHED

SH-2800-P



Glass thickness: 6-12mm  
Main material: Stainless Steel/Copper  
Finish: Polished  
ø Hole Diameter 10 mm

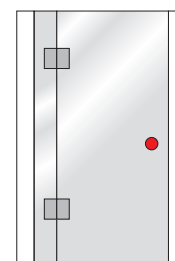
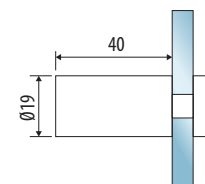
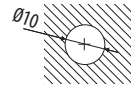

SH-2800-P

### SINGLE SIDED DOOR KNOB - SATIN

SH-2800-S



Glass thickness: 6-12mm  
Main material: Stainless Steel/Copper  
Finish: Polished  
ø Hole Diameter 10 mm

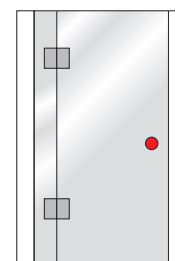
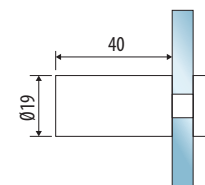
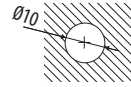

SH-2800-S

### DOUBLE SIDED DOOR KNOB - POLISHED

SH-2801D-P



Glass thickness: 6-12mm  
Main material: Stainless Steel/Copper  
Finish: Polished  
ø Hole Diameter 10 mm

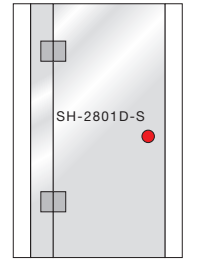
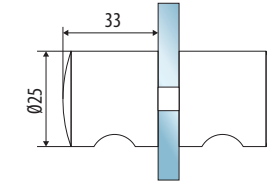
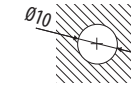

SH-2801D-S

### DOUBLE SIDED DOOR KNOB - SATIN

SH-2801D-S



Glass thickness: 6-12mm  
Main material: Stainless Steel/Copper  
Finish: Satin  
ø Hole Diameter 10 mm

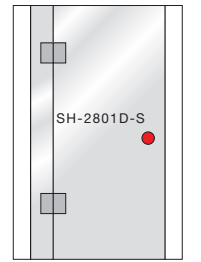
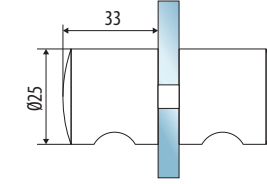
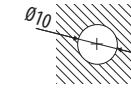

SH-2801D-S

### SINGLE SIDED DOOR KNOB - POLISHED

SH-2801-P



Glass thickness: 6-12mm  
Main material: Stainless Steel/Copper  
Finish: Polished  
ø Hole Diameter 10 mm

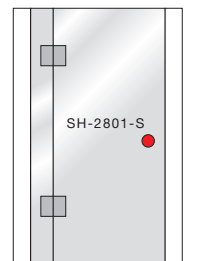
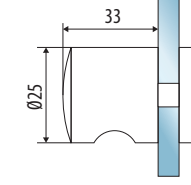
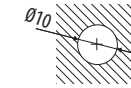

SH-2801-S

### SINGLE SIDED DOOR KNOB - SATIN

SH-2801-S



Glass thickness: 6-12mm  
Main material: Stainless Steel/Copper  
Finish: Satin  
ø Hole Diameter 10 mm

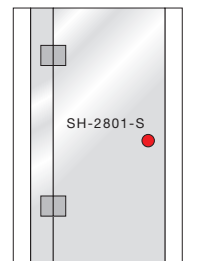
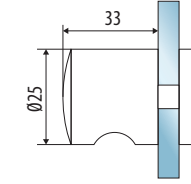
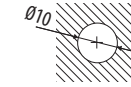

SH-2801-S

### DOUBLE SIDED DOOR KNOB - POLISHED

SH-2803D-HD-P



Glass thickness: 6-12mm  
Main material: Stainless Steel/Copper  
Finish: Polished  
ø Hole Diameter 10 mm

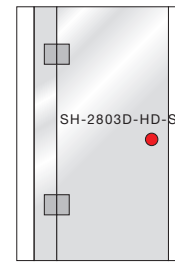
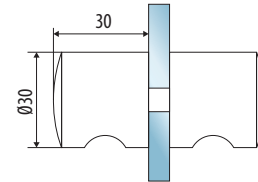
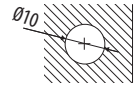

### DOUBLE SIDED DOOR KNOB - SATIN

SH-2803D-HD-S



Glass thickness: 6-12mm  
Main material: Stainless Steel/Copper  
Finish: Satin  
ø Hole Diameter 10 mm

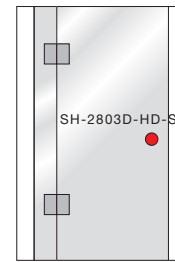
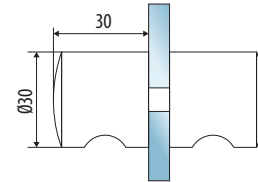
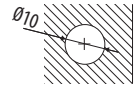

### SINGLE SIDED DOOR KNOB - POLISHED

SH-2803-HD-P



Glass thickness: 6-12mm  
Main material: Stainless Steel/Copper  
Finish: Polished  
ø Hole Diameter 10 mm

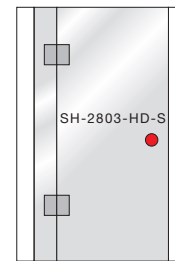
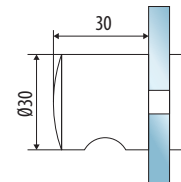
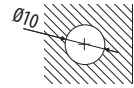

### SINGLE SIDED DOOR KNOB - SATIN

SH-2803-HD-S



Glass thickness: 6-12mm  
Main material: Stainless Steel/Copper  
Finish: Satin  
ø Hole Diameter 10 mm

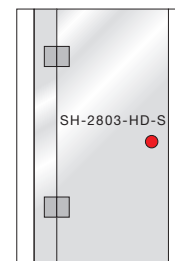
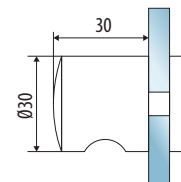
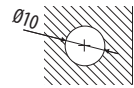

### DOUBLE SIDED CONICAL KNOB - POLISHED

SH-2804-HD-P



Glass thickness: 6-12mm  
Main material: Stainless Steel/Copper  
Finish: Polished  
ø Hole Diameter 10 mm

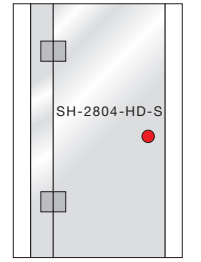
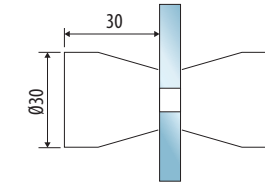
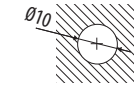

### DOUBLE SIDED CONICAL KNOB - SATIN

SH-2804-HD-S



Glass thickness: 6-12mm  
Main material: Stainless Steel/Copper  
Finish: Satin  
ø Hole Diameter 10 mm

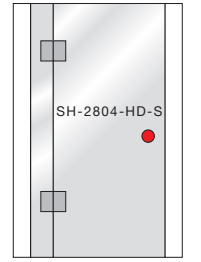
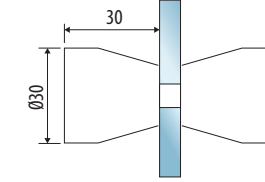
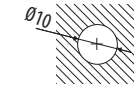

### DOUBLE SIDED CONICAL KNOB - POLISHED

SH-2804-P



Glass thickness: 6-12mm  
Main material: Stainless Steel/Copper  
Finish: Polished  
ø Hole Diameter 10 mm

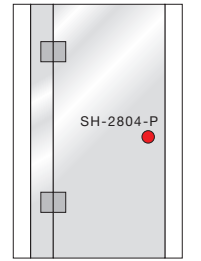
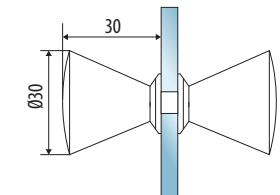
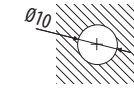

### DOUBLE SIDED CONICAL KNOB - SATIN

SH-2804-S



Glass thickness: 6-12mm  
Main material: Stainless Steel/Copper  
Finish: Satin  
ø Hole Diameter 10 mm

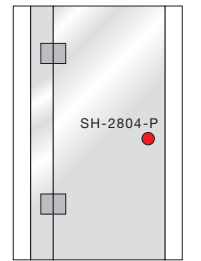
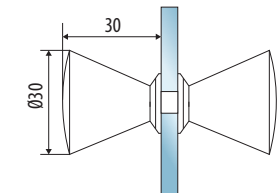
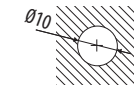



# LINKAN

## Shower Door Handles

### TOWEL RAIL / HANDLE - POLISHED

SH-2820-P



Glass thickness: 6-12mm  
Main material: Stainless Steel/Copper  
Finish: Polished  
ø Hole Diameters 10 mm

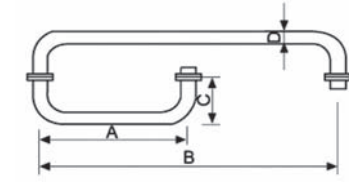

	Dimensions (mm)			
	A	B	C	D
19x305x610	305	610	62	Ø19
19x152x457	152	457	62	Ø19

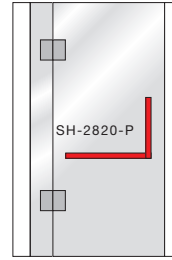
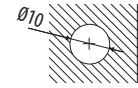

### TOWEL RAIL / HANDLE - SATIN

SH-2820-S



Glass thickness: 6-12mm  
Main material: Stainless Steel/Copper  
Finish: Satin  
ø Hole Diameters 10 mm

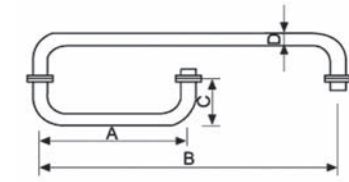

Formato	Dimensions (mm)			
	A	B	C	D
19x305x610	305	610	62	Ø19
19x152x457	152	457	62	Ø19

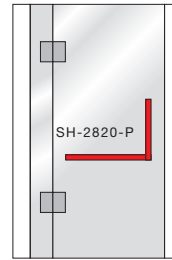
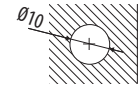

### HANDLE 335mm - POLISHED

SH-2821D-P



Glass thickness: 6-12mm  
Main material: Stainless Steel/Copper  
Finish: Polished  
ø Hole Diameters 12 mm

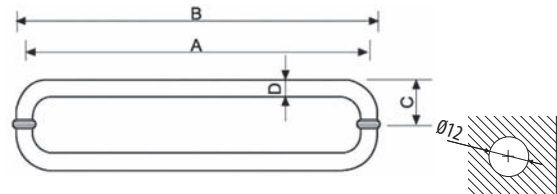

	Dimensions (mm)			
	A	B	C	D
25x305	305	335	72	Ø25

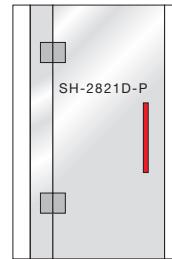
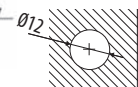

### HANDLE 335MM - SATIN

SH-2821D-S



Glass thickness: 6-12mm  
Main material: Stainless Steel/Copper  
Finish: Satin  
ø Hole Diameters 12 mm

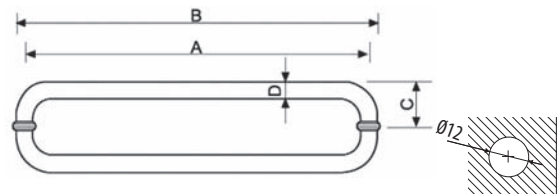

	Dimensions (mm)			
	A	B	C	D
25x305	305	335	72	Ø25

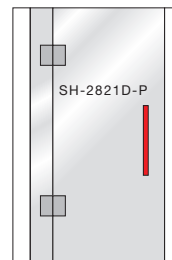
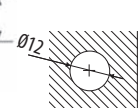

# LINKAN

## Shower Door Handles

### HANDLE 335mm - POLISHED

SH-2822-P



Glass thickness: 6-12mm  
Main material: Stainless Steel/Copper  
Finish: Polished  
ø Hole Diameters 12 mm

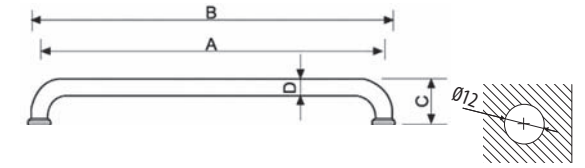

	Dimensions (mm)			
	A	B	C	D
25x305	305	335	72	Ø25

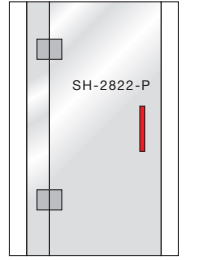
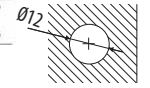

### HANDLE 335MM - SATIN

SH-2822-S



Glass thickness: 6-12mm  
Main material: Stainless Steel/Copper  
Finish: Satin  
ø Hole Diameters 12 mm

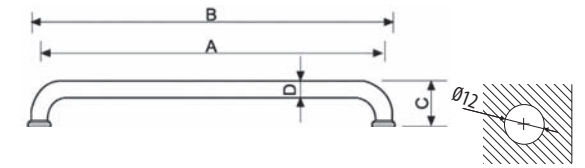

	Dimensions (mm)			
	A	B	C	D
25x305	305	335	72	Ø25

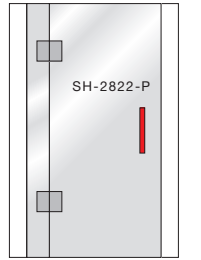
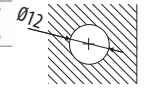

### HANDLE 176mm - POLISHED

SH-2821D-P



Glass thickness: 6-12mm  
Main material: Stainless Steel/Copper  
Finish: Polished  
ø Hole Diameters 10 mm

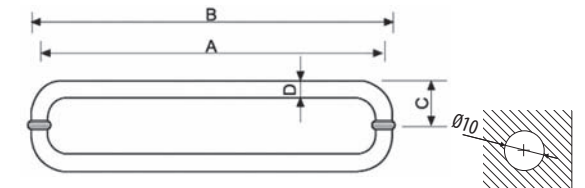

	Dimensions (mm)			
	A	B	C	D
19x152	152	176	62	Ø19

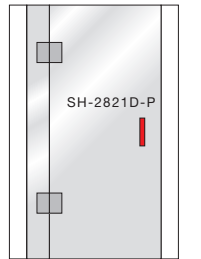
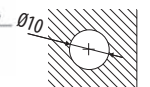

### HANDLE 176MM - SATIN

SH-2821D-S



Glass thickness: 6-12mm  
Main material: Stainless Steel/Copper  
Finish: Satin  
ø Hole Diameters 10 mm

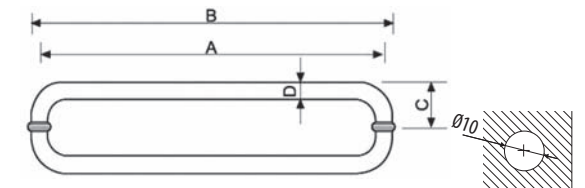

	Dimensions (mm)			
	A	B	C	D
19x152	152	176	62	Ø19

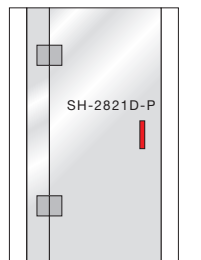
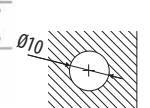

### C-HANDLE - POLISHED

SH-2823-P



Glass thickness: 6-12mm  
Main material: Stainless Steel/Copper  
Finish: Polished

Ø Hole Diameters 12 mm

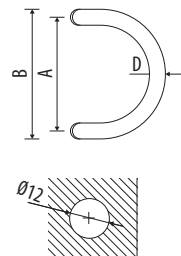

FORMATO	SIZE (mm)			
	A	B	C	D
25 x 305	305	330	72	Ø25

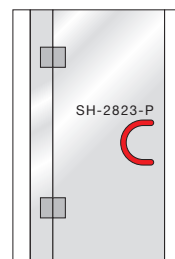

### C-HANDLE - SATIN

SH-2823-S



Glass thickness: 6-12mm  
Main material: Stainless Steel/Copper  
Finish: Satin

Ø Hole Diameters 12 mm

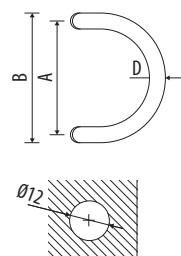

FORMATO	SIZE (mm)			
	A	B	C	D
25 x 305	305	330	72	Ø25

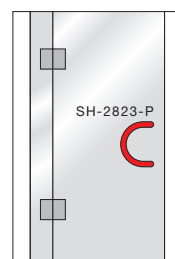

# GLASS HARDWARE

### Best Quality, Competitively Priced

Anti corrosion guarantee  
Manufactured to the highest standards  
Designed to last

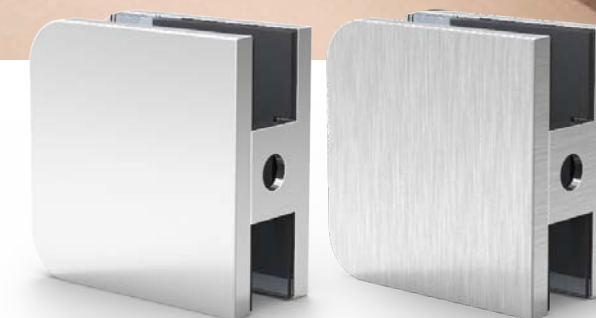

POLISHED

SATIN



### GLASS TO WALL CONNECTOR - POLISHED

GH-2541-P



Glass thickness: 6-12mm  
Main material: Stainless Steel/Copper  
Finish: Polished

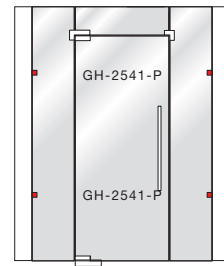
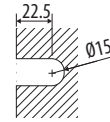
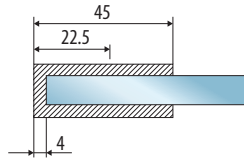

### GLASS TO WALL CONNECTOR - SATIN

GH-2541-S



Glass thickness: 6-12mm  
Main material: Stainless Steel/Copper  
Finish: Polished

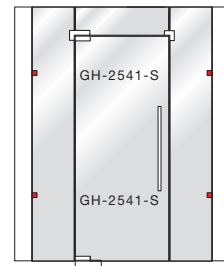
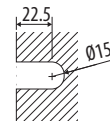
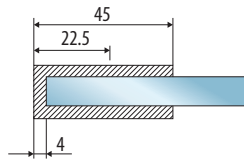

### GLASS TO GLASS IN-LINE CONNECTOR - POLISHED

GH-2544-P



Glass thickness: 6-12mm  
Main material: Stainless Steel/Copper  
Finish: Polished

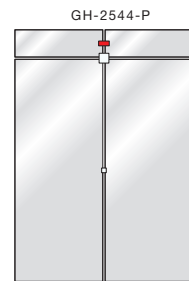
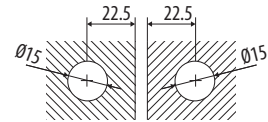
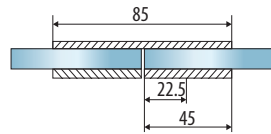

### GLASS TO GLASS IN-LINE CONNECTOR - SATIN

GH-2544-S



Glass thickness: 6-12mm  
Main material: Stainless Steel/Copper  
Finish: Satin

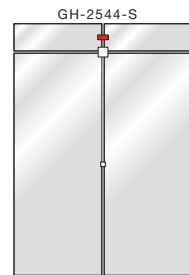
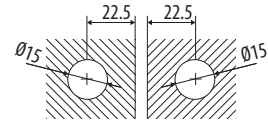
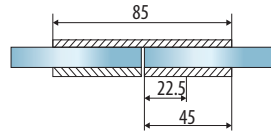

### GLASS TO GLASS CONNECTOR 90 DEGREES - POLISHED

GH-2545-P



Glass thickness: 6-12mm  
Main material: Stainless Steel/Copper  
Finish: Polished

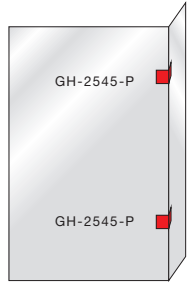
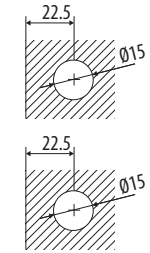
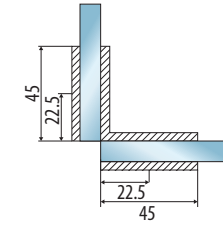

### GLASS TO GLASS CONNECTOR 90 DEGREES - SATIN

GH-2545-S



Glass thickness: 6-12mm  
Main material: Stainless Steel/Copper  
Finish: Satin

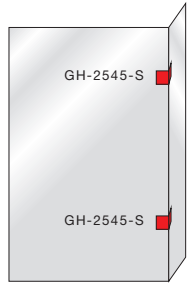
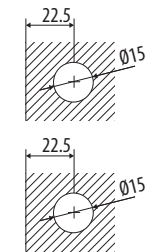
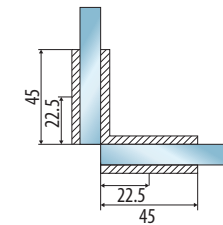

### GLASS TO GLASS CONNECTOR 135 DEGREES - POLISHED

GH-2546-P



Glass thickness: 6-12mm  
Main material: Stainless Steel/Copper  
Finish: Polished

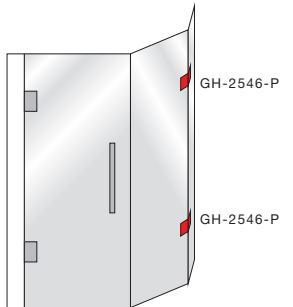
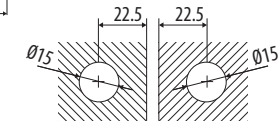
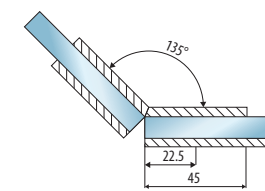

### GLASS TO GLASS CONNECTOR 135 DEGREES - SATIN

GH-2546-S



Glass thickness: 6-12mm  
Main material: Stainless Steel/Copper  
Finish: Satin

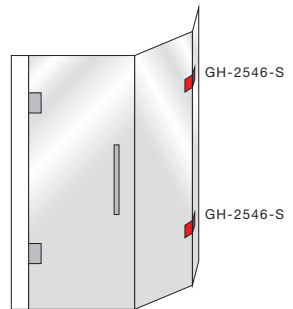
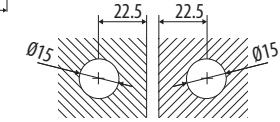
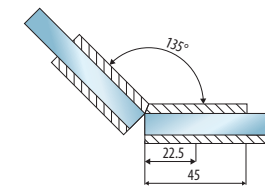

### GLASS TO GLASS 4-WAY CONNECTOR - POLISHED

GH-1314B-P



Glass thickness: 10-12mm  
Main material: Stainless Steel/Copper  
Finish: Polished

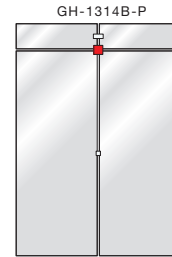
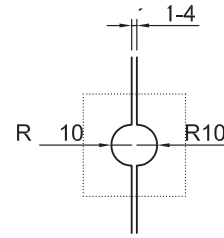
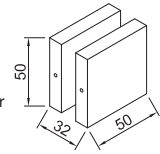

### GLASS TO GLASS 4-WAY CONNECTOR - SATIN

GH-1314B-S



Glass thickness: 10-12mm  
Main material: Stainless Steel/Copper  
Finish: Satin

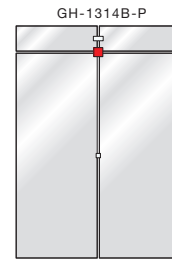
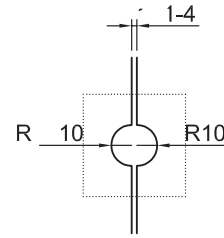
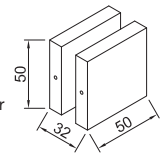

### PREMIUM GLASS TO GLASS L-SHAPED CONNECTOR - POLISHED

GH-1314-SM-P



Glass thickness: 10-12mm  
Main material: Stainless Steel/Copper  
Finish: Polished

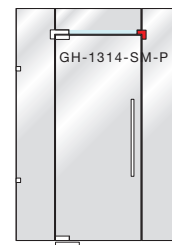
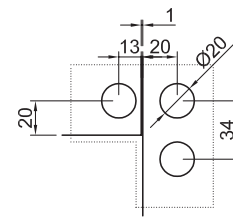
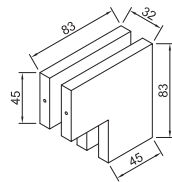

### PREMIUM GLASS TO GLASS L-SHAPED CONNECTOR - SATIN

GH-1314-SM-S



Glass thickness: 10-12mm  
Main material: Stainless Steel/Copper  
Finish: Satin

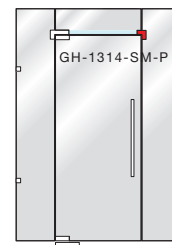
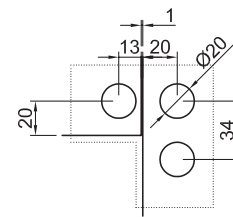
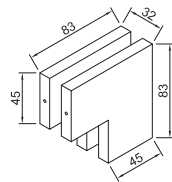

### PREMIUM LEFT UPPER PIVOT PATCH WITH FIN - POLISHED

GH-1318-L-P



Glass thickness: 10-12mm  
Main material: Stainless Steel/Copper  
Finish: Polished

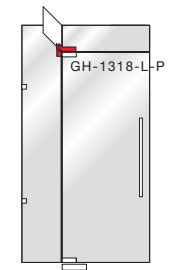
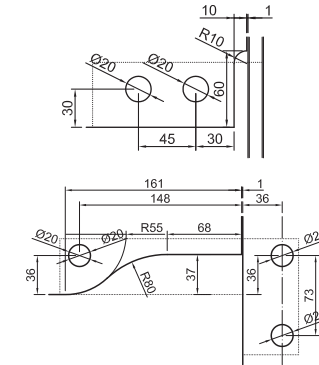
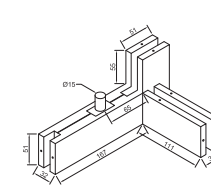

### PREMIUM LEFT UPPER PIVOT PATCH WITH FIN - SATIN

GH-1318-L-S



Glass thickness: 10-12mm  
Main material: Stainless Steel/Copper  
Finish: Satin

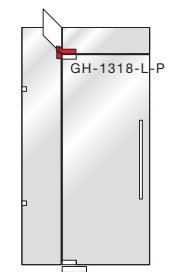
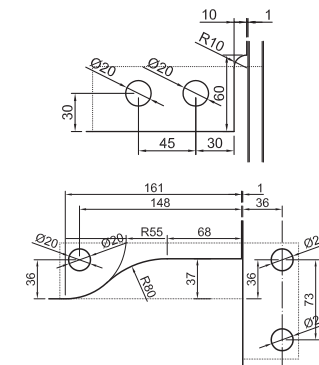
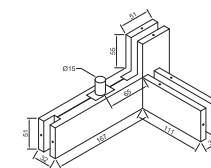

### PREMIUM RIGHT UPPER PIVOT PATCH WITH FIN - POLISHED

GH-1318-R-P



Glass thickness: 10-12mm  
Main material: Stainless Steel/Copper  
Finish: Polished

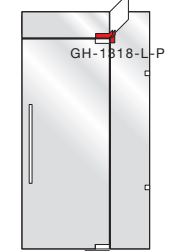
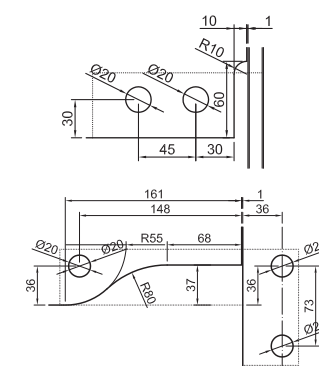
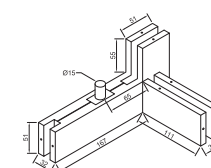

### PREMIUM RIGHT UPPER PIVOT PATCH WITH FIN - SATIN

GH-1318-R-S



Glass thickness: 10-12mm  
Main material: Stainless Steel/Copper  
Finish: Satin

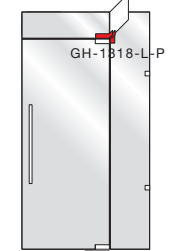
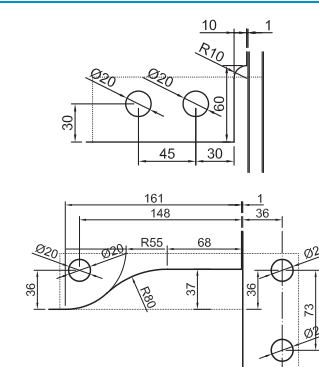
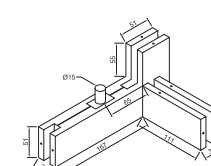



### PREMIUM UPPER DOUBLE PIVOT PATCH - POLISHED

GH-1319-P



Glass thickness: 10-12mm  
Bearing weight: ≤1kg  
Main material: Stainless Steel/Copper  
Finish: Polished

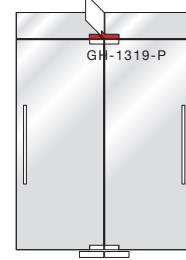
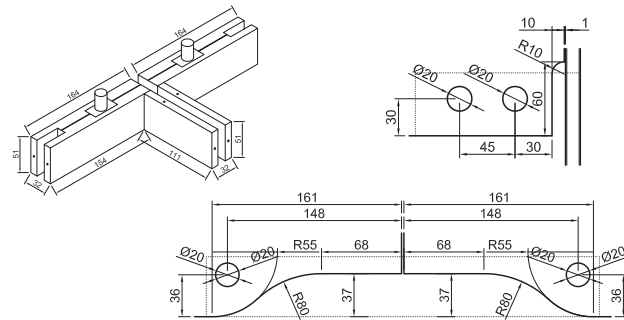

### PREMIUM UPPER DOUBLE PIVOT PATCH - SATIN

GH-1319-S



Glass thickness: 10-12mm  
Bearing weight: ≤1kg  
Main material: Stainless Steel/Copper  
Finish: Satin

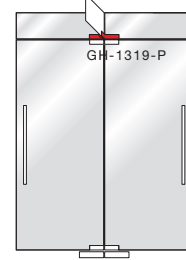
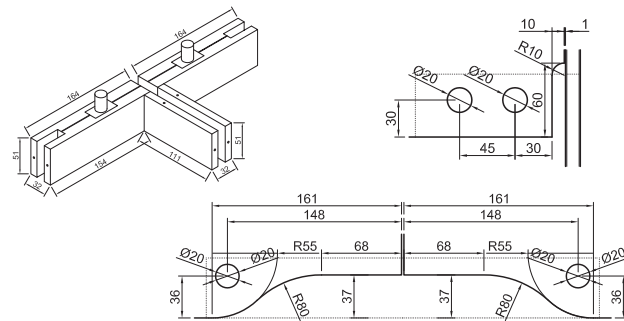

### GLASS TO GLASS 5-WAY CONNECTOR - POLISHED

GH-1320-P



Glass thickness: 10-12mm  
Bearing weight: ≤1kg  
Main material: Stainless Steel/Copper  
Finish: Polished

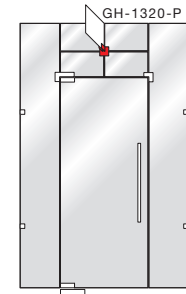
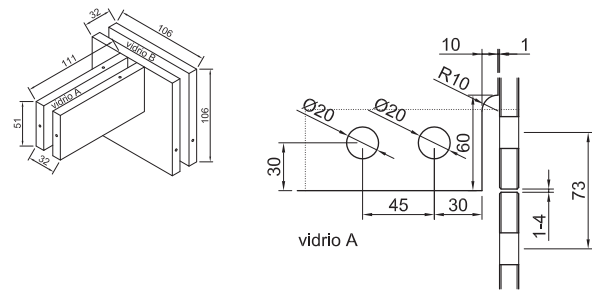

### GLASS TO GLASS 5-WAY CONNECTOR - SATIN

GH-1320-S



Glass thickness: 10-12mm  
Bearing weight: ≤1kg  
Main material: Stainless Steel/Copper  
Finish: Satin

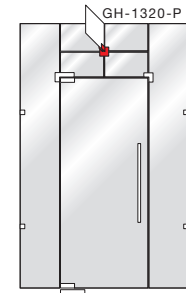
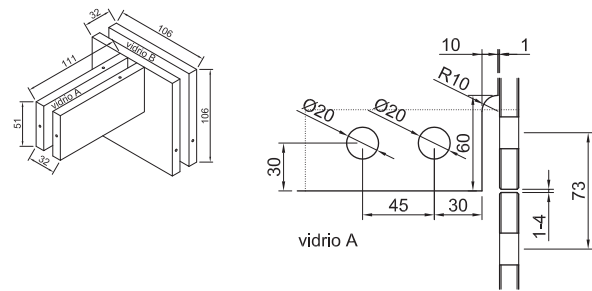

### PREMIUM GLASS TO GLASS 3-WAY CONNECTOR - POLISHED

GH-TD-189-P



Glass thickness: 10-12mm  
Main material: Stainless Steel/Copper  
Finish: Polished

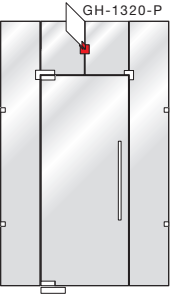
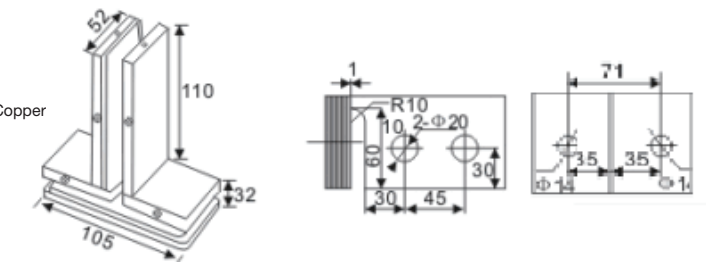

### PREMIUM GLASS TO GLASS 3-WAY CONNECTOR - SATIN

GH-TD-189-S



Glass thickness: 10-12mm  
Main material: Stainless Steel/Copper  
Finish: Satin

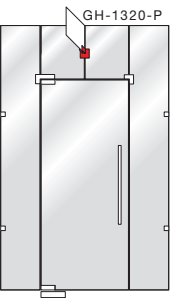
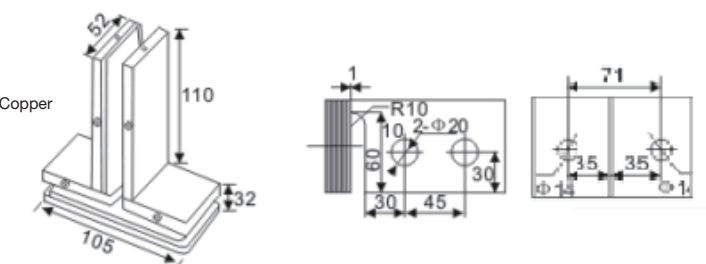

### PREMIUM PIVOT RECEIVER PATCH - POLISHED

GH-1322-P



Glass thickness: 10-12mm  
Main material: Stainless Steel/Copper  
Finish: Polished

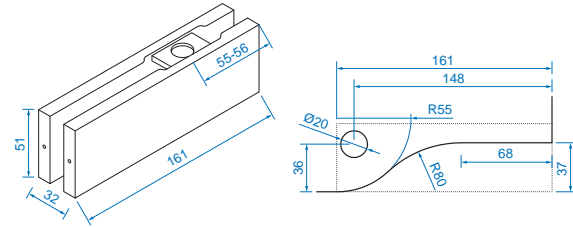

### PREMIUM UPPER PIVOT PATCH - POLISHED

GH-1324-P



Glass thickness: 10-12mm  
Main material: Stainless Steel/Copper  
Finish: Polished

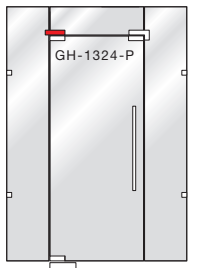
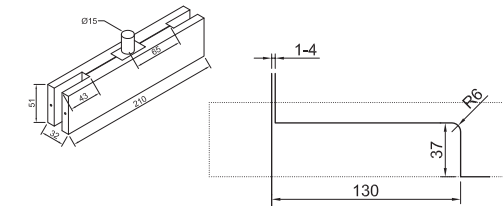

### PREMIUM PIVOT RECEIVER PATCH - SATIN

GH-1322-S



Glass thickness: 10-12mm  
Main material: Stainless Steel/Copper  
Finish: Satin

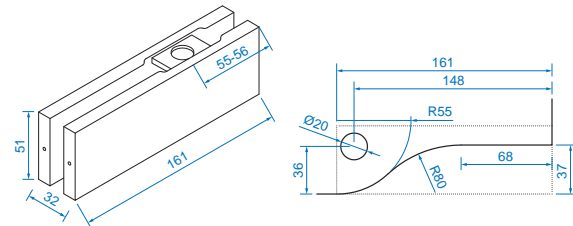

### PREMIUM UPPER PIVOT PATCH - SATIN

GH-1324-S



Glass thickness: 10-12mm  
Main material: Stainless Steel/Copper  
Finish: Satin

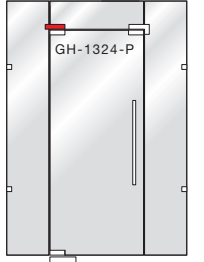
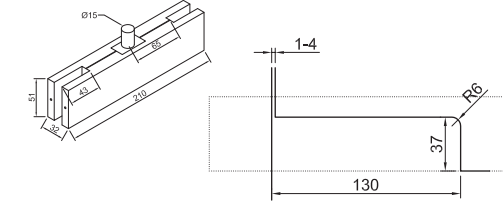

### PREMIUM PIVOT PATCH WITH EXPANSION SCREW - POLISHED

GH-1323-P



Glass thickness: 10-12mm  
Main material: Stainless Steel/Copper  
Finish: Polished

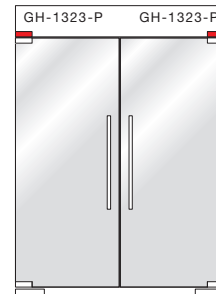
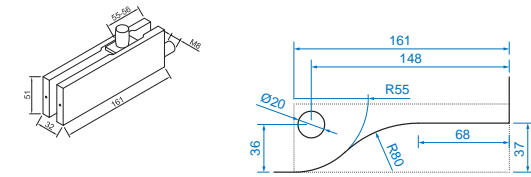

### PREMIUM CORNER PIVOT PATCH - POLISHED

GH-1324B-P



Glass thickness: 10-12mm  
Main material: Stainless Steel/Copper  
Finish: Polished

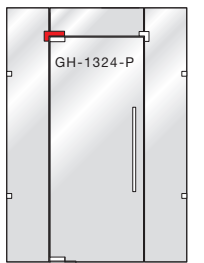
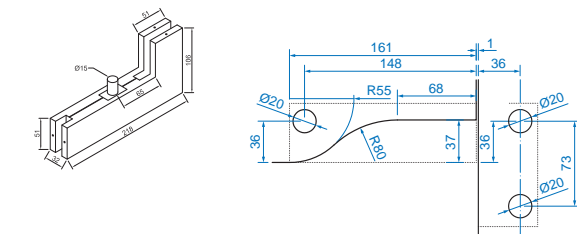

### PREMIUM PIVOT PATCH WITH EXPANSION SCREW - SATIN

GH-1323-S



Glass thickness: 10-12mm  
Main material: Stainless Steel/Copper  
Finish: Satin

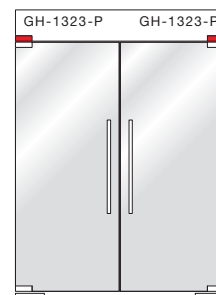
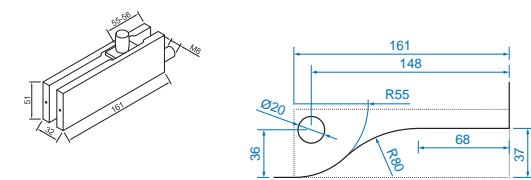

### PREMIUM CORNER PIVOT PATCH - SATIN

GH-1324B-S



Glass thickness: 10-12mm  
Main material: Stainless Steel/Copper  
Finish: Satin

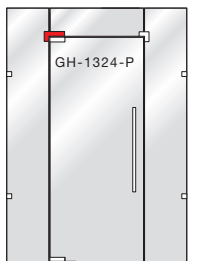
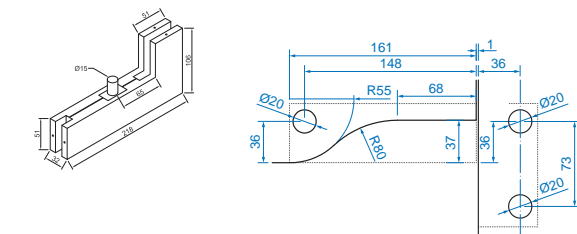



### CENTRAL LOCK PATCH - POLISHED

GH-1326-P



Glass thickness: 10-12mm  
Main material: Stainless Steel/Copper  
Finish: Polished

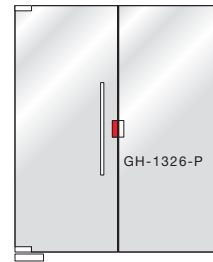
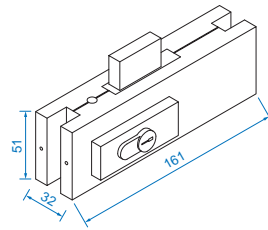

### CENTRAL LOCK PATCH - SATIN

GH-1326-S



Glass thickness: 10-12mm  
Main material: Stainless Steel/Copper  
Finish: Satin

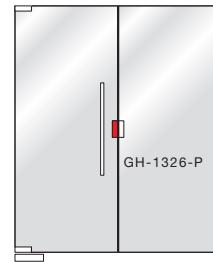
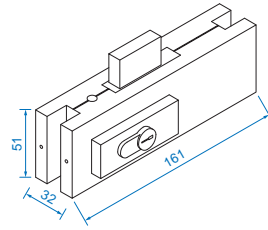

### CENTRAL STRIKE PATCH - POLISHED

GH-1327-P



Glass thickness: 10-12mm  
Main material: Stainless Steel/Copper  
Finish: Polished

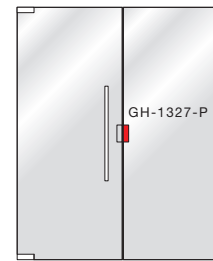
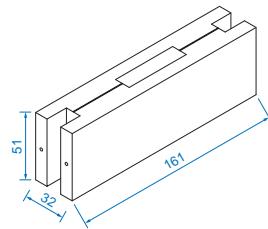

### CENTRAL STRIKE PATCH - SATIN

GH-1327-S



Glass thickness: 10-12mm  
Main material: Stainless Steel/Copper  
Finish: Satin

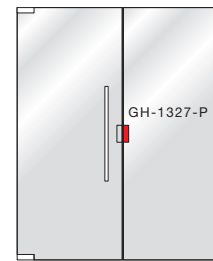
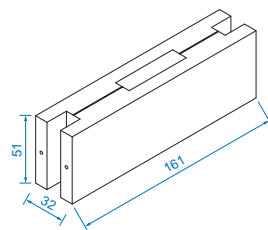

### LOWER PIVOT RECEIVER PATCH - POLISHED

GH-1321-P



Glass thickness: 10-12mm  
Main material: Stainless Steel/Copper  
Finish: Polished

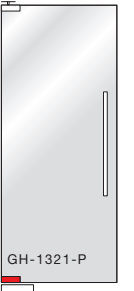
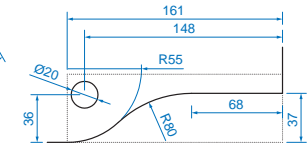
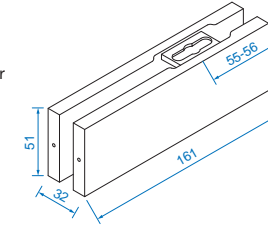

### LOWER PIVOT RECEIVER PATCH - SATIN

GH-1321-S



Glass thickness: 10-12mm  
Main material: Stainless Steel/Copper  
Finish: Satin

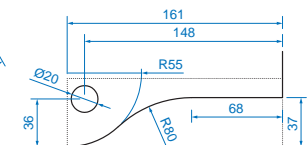
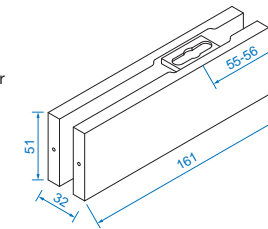

### CORNER LOCK RECEIVER PATCH - POLISHED

GH-1330-P



Glass thickness: 10-12mm  
Main material: Stainless Steel/Copper  
Finish: Polished

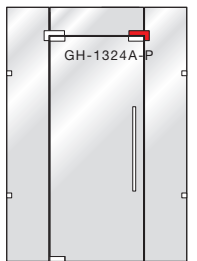
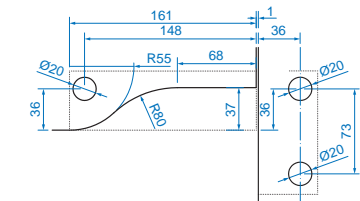
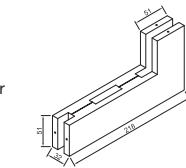

### CORNER LOCK RECEIVER PATCH - SATIN

GH-1330-S



Glass thickness: 10-12mm  
Main material: Stainless Steel/Copper  
Finish: Satin

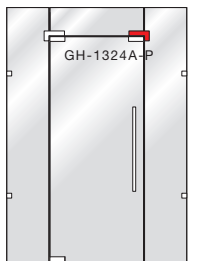
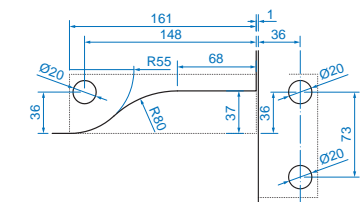
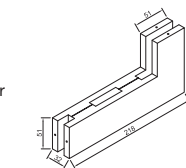

## 2 ARM GLASS SPIDER CLAMP

GH-2002T

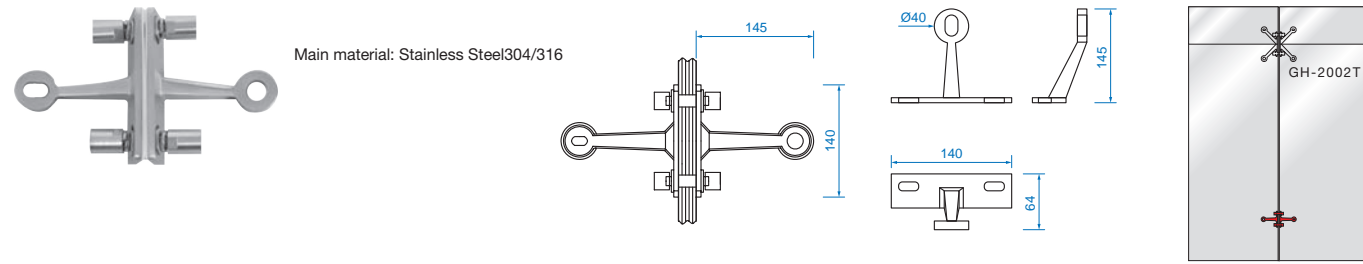

## 4 ARM GLASS SPIDER CLAMP

GH-2004T

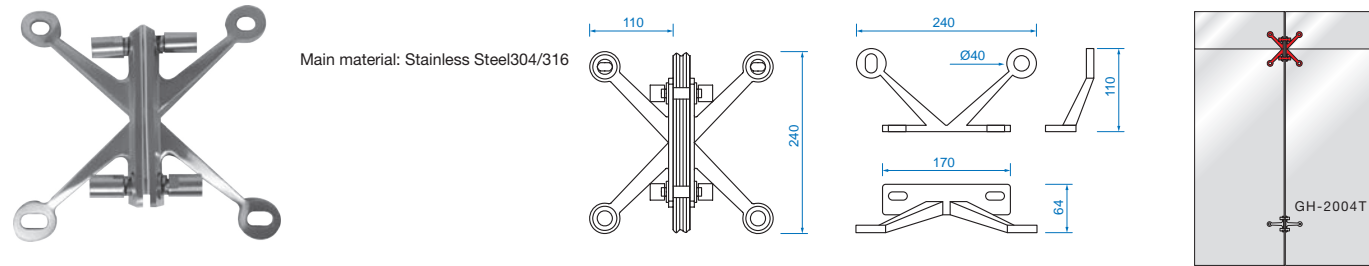

## GLASS ANCHOR TO FLAT SURFACE

GH-A01-M18

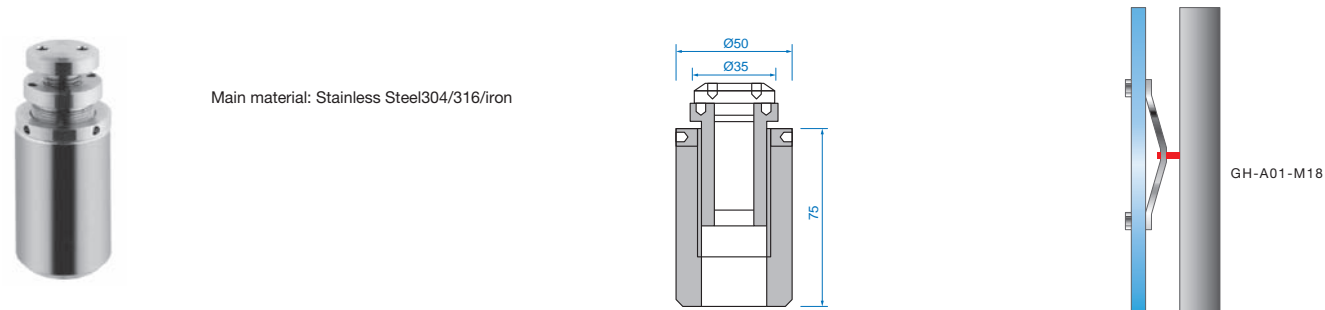

## GLASS ANCHOR TO CURVED SURFACE

GH-A01-M18-R54

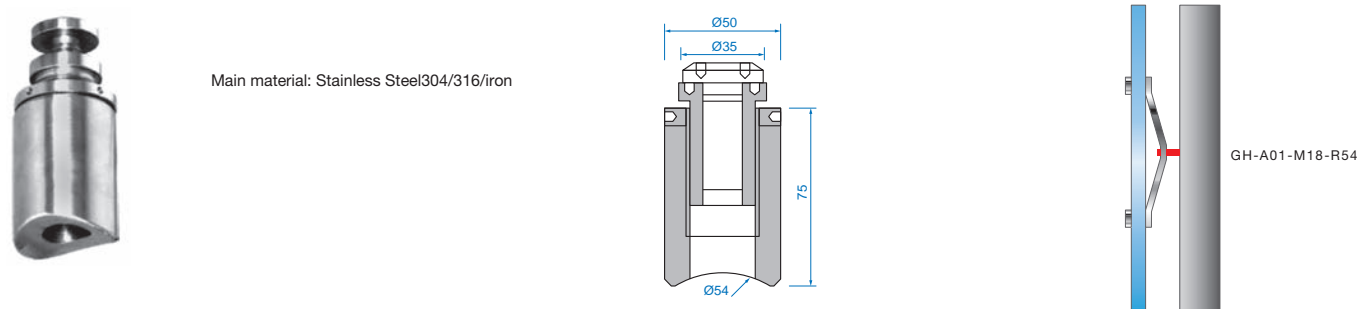

## GLASS TO GLASS STAPLE STANDARD

GH-C250x40

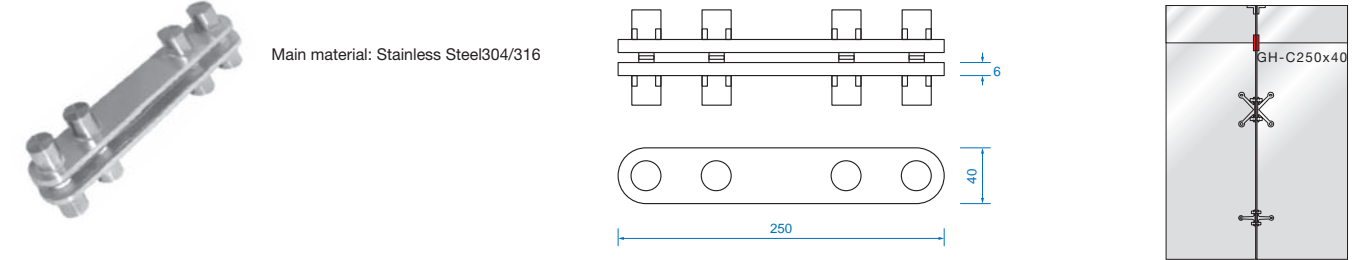

## GLASS TO GLASS STAPLE LARGE

GH-C380x60

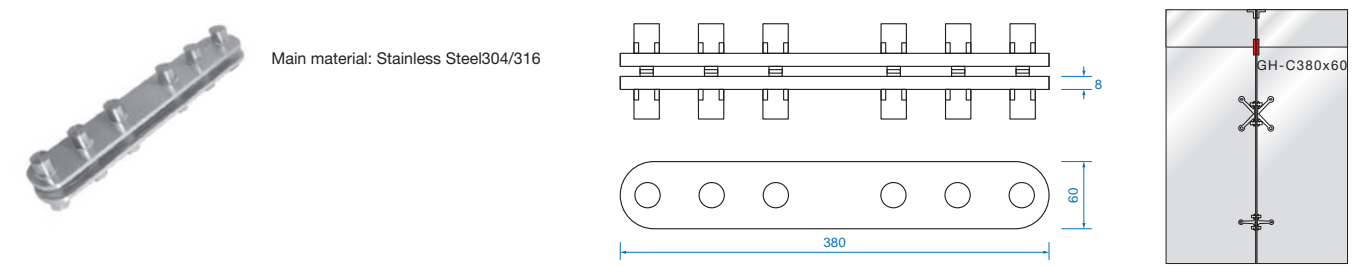

## GLASS TO CEILING SUPPORT STANDARD

GH-400x93x93

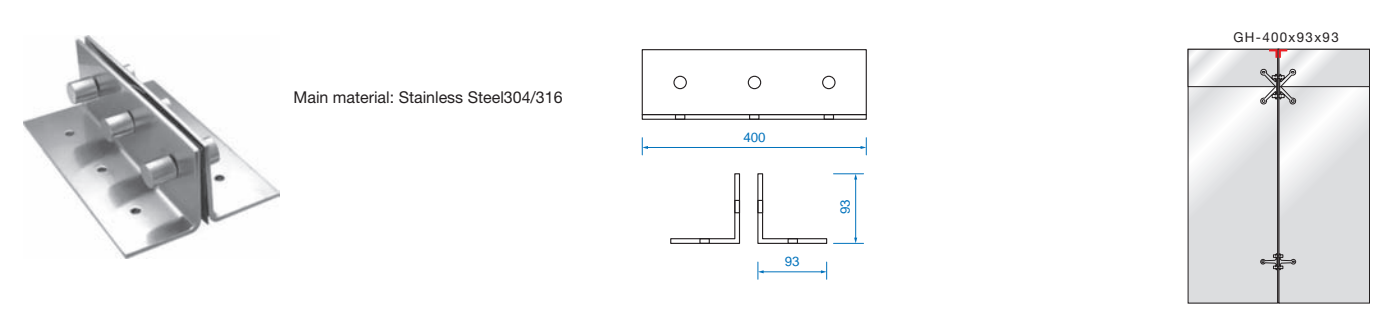

## GLASS TO CEILING SUPPORT LARGE

GH-250x75x75

